

Data sheet | Item number: 286-328

Relay module; Nominal input voltage: 24 VDC; 2 make contact; Limiting continuous current: 6 A; Red status indicator; Module width: 20 mm

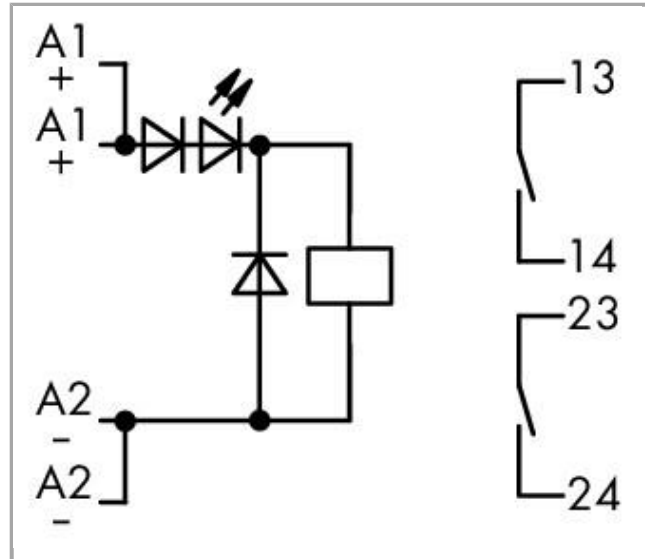

286-328

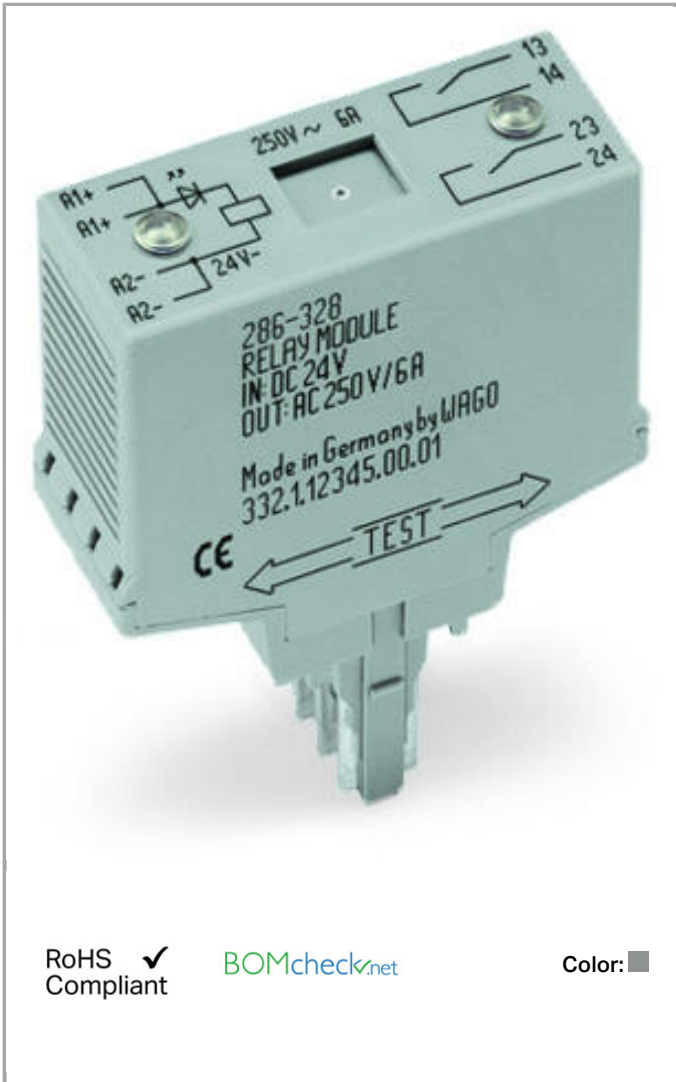

RoHS Compliant

[BOMcheck.net](https://www.bomcheck.net)

Color: ■

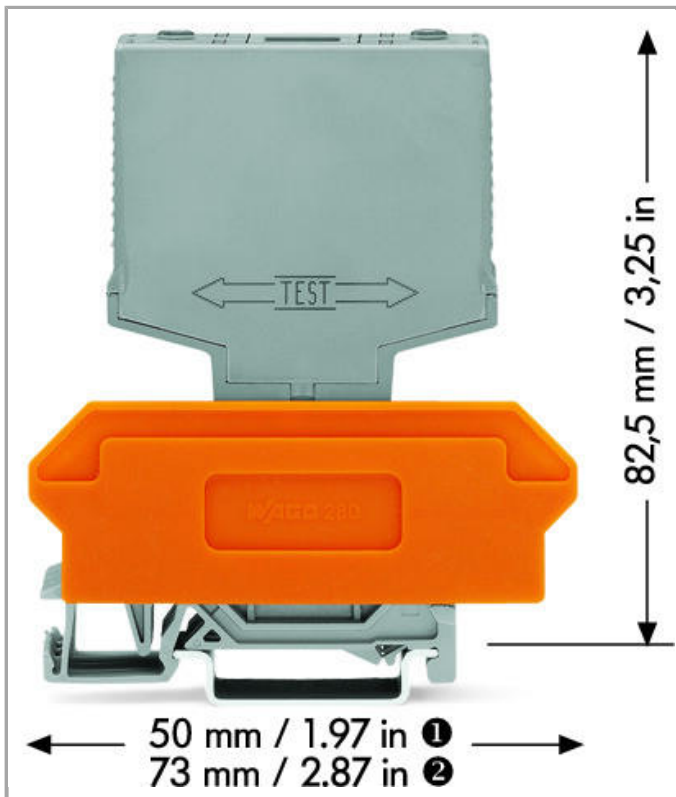

Data

Technical Data

Control circuit

Nominal input voltage U_N	DC 24 V
Input voltage range	$\pm 10\%$
Nominal input current at U_N	7.4 mA

Load circuit:

Number of make contacts/switch on contacts	2
Contact material (relay)	AgSnO ₂
Limiting continuous current	6 A
Max. make current (resistive)	(AC) 15 A / 1 s
Max. switching voltage	AC 250 V
Max. switching power (resistive)	AC 1,500 VA
Min. switching current	0 μ A
Pull-in time (typ.)	10 ms
Drop-out time (typ.)	4 ms
Bounce time (typ)	1 ms
Drop-out time	$\leq 0 \mu$ s

Electrical life (N.O.; resistive load; 23 °C)	100 x 10 ³ switching operations
---	--

Mechanical life (N.O.; resistive load; 23 °C)	50 x 10 ⁶ switching operations
---	---

Signaling

Status indication	LED red
-------------------	---------

Safety and protection:

Rated voltage	250 V
---------------	-------

Rated impulse voltage	4 kV
-----------------------	------

Pollution degree	2
------------------	---

Dielectric strength, control/load circuit (AC, 1 min)	3 kVrms
---	---------

Dielectric strength open contact (AC, 1 min)	1 kVrms
--	---------

Dielectric strength, load/load circuit (AC, 1 min)	1.5 kVrms
--	-----------

Protection class	IP20
------------------	------

Geometrical Data

Width	20 mm / 0.787 inch
-------	--------------------

Height from upper-edge of DIN-35 rail	82.5 mm / 3.248 inch
---------------------------------------	----------------------

Depth	52 mm / 1.654 inch
-------	--------------------

Mechanical data

Type of mounting	Pluggable module for carrier terminal blocks
------------------	--

Material Data

Color	gray
-------	------

Fire load	0.65 MJ
-----------	---------

Weight	28.5 g
--------	--------

Environmental Requirements

Pollution degree	2
------------------	---

Surrounding air (operating) temperature at U _N	-25 ... 40 °C
---	---------------

Surrounding air (storage) temperature	-25 ... 70 °C
---------------------------------------	---------------

Standards and specifications

Standards/specifications	EN 60664-1
--------------------------	------------









Commercial data

Product Group	6 (Interface Electronics)
---------------	---------------------------



Country of origin	DE
GTIN	4045454319540
Customs Tariff No.	85364900990

Compatible products

Marking accessories

	Item no.: 209-701 WSB marking card; as card; not stretchable; plain; snap-on type	209-701
	Item no.: 209-701/000-002 WSB marking card; as card; not stretchable; plain; snap-on type	209-701 /000-002
	Item no.: 209-701/000-005 WSB marking card; as card; not stretchable; plain; snap-on type	209-701 /000-005
	Item no.: 209-701/000-006 WSB marking card; as card; not stretchable; plain; snap-on type	209-701 /000-006
	Item no.: 209-701/000-007 WSB marking card; as card; not stretchable; plain; snap-on type	209-701 /000-007
	Item no.: 209-701/000-012 WSB marking card; as card; not stretchable; plain; snap-on type	209-701 /000-012
	Item no.: 209-701/000-017 WSB marking card; as card; not stretchable; plain; snap-on type	209-701 /000-017
	Item no.: 209-701/000-023 WSB marking card; as card; not stretchable; plain; snap-on type	209-701 /000-023
	Item no.: 209-701/000-024 WSB marking card; as card; not stretchable; plain; snap-on type	209-701 /000-024

General accessories

	Item no.: 280-628 Terminal block for pluggable modules; 16-pole; with 4-conductor terminal blocks; with orange separator; for DIN-rail 35 x 15 and 35 x 7.5; 2.5 mm ² ; CAGE CLAMP®	280-628
	Item no.: 280-638 Terminal block for pluggable modules; 8-pole; with 2-conductor terminal blocks; with orange separator; for DIN-rail 35 x 15 and 35 x 7.5; 2.5 mm ² ; CAGE CLAMP®	280-638
	Item no.: 280-764 Terminal block for pluggable modules; 16-pole; with 4-conductor terminal blocks; with marker carrier; with orange separator; for DIN-rail 35 x 15 and 35 x 7.5; 2.5 mm ² ; CAGE CLAMP®	280-764



Downloads

Documentation

Bid Text

286-328 Relaisbaustein	Jan 22, 2016	doc 26.6 kB	Download
---------------------------	--------------	----------------	----------

Additional Information

Disposal; Electrical and electronic equipment, Packaging	V 1.0.0	pdf 265.8 kB	Download
--	---------	-----------------	----------

CAD/CAE - Smart Data

CAD data

3D Download 286-328		URL	Download
---------------------	--	-----	----------

Subject to changes.
